

## 1140-LU-F

CHASSIS MOUNT  
LINE OUTPUT TRANSFORMER

This transformer is designed with quad-filar windings and a 80% Ni core, which gives very low distortion levels and good output levels.

It can drive 600Ω loads up to +27dbu @ 20Hz.

This transformer is best suited for 1:2 step up applications.

If a 1:1 ratio is needed, better performance can be obtained from the 1140-LU-G

Due to the properties of the Ni core, the drive signal should have no DC component and the source impedance should be as low as possible.

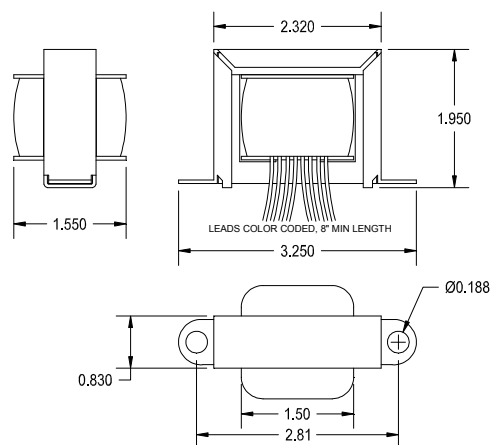

### ELECTRICAL SPECIFICATIONS

Characteristic	Conditions	Typical
Input Impedance		600 Ω
Output Impedance		600 Ω
Primary Input Impedance	@ 1kHz 0dbu Test Circuit 3	180Ω
Secondary Output Impedance	@ 1kHz 0dbu Test Circuit 4	80Ω
Maximum input Level	@ 20Hz RL = 600Ω	+27 dbu
DCR		
Primary	@20°C	30/30 Ω
Secondary	@20°C	30/30 Ω
Frequency Response	@ 20 Hz, 0 dbu, Test Circuit 3	-0.001db
	@ 20 kHz, 0 dbu, Test Circuit 3	+0.007db
Turns ratio		1:1
Common Mode Rejection Level	@ 60 Hz, 0 dbu, Test Circuit 2	105db
	3kHz, 0 dbu, Test Circuit 2	75db
THD	@ 1kHz 4 dbu Test Circuit 1	0.007%
	@ 20Hz 4 dbu Test Circuit 1	0.001%
Phase Shift	@ 20 Hz Test Circuit 1	0.08°
	@ 20 kHz Test Circuit 1	-3.80°
Capacitance	Primary to Shield and Case	30nf
	Secondary to Shield and Case	80pf
Dielectric Strength		250 Vrms

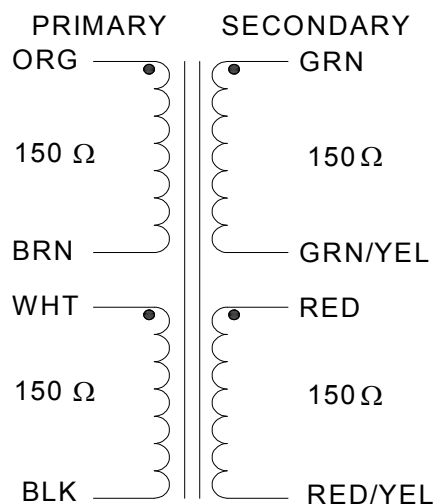
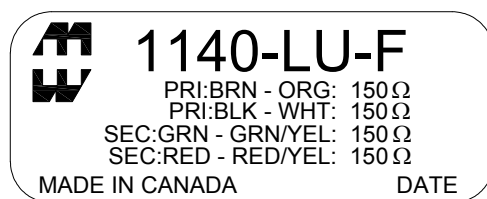

### 1140-LU-F FREQUENCY RESPONSE

Input level 0dBu  
Rs = 0Ω, RL = 600Ω

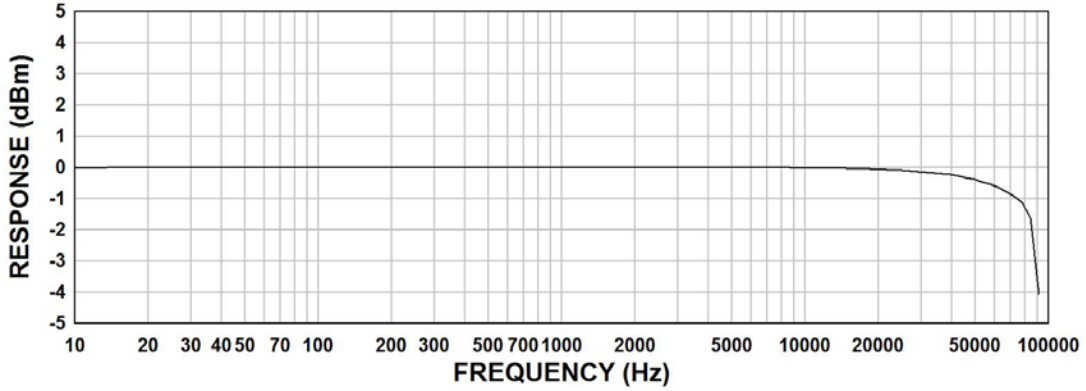

### 1140-LU-F PHASE SHIFT

Input Level 0 dBu  
Rs = 0Ω, RL = 600Ω

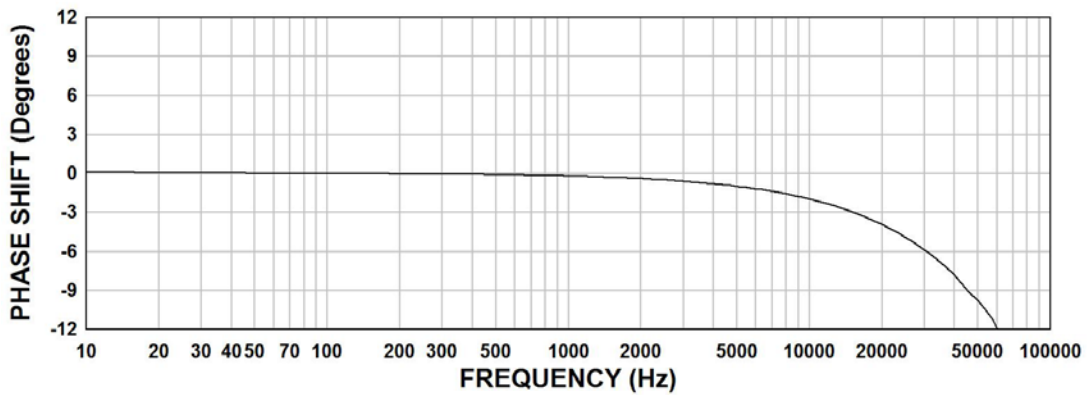

### 1140-LU-F THD+N

Input Level +4dBu  
Rs = 0Ω, RL = 600Ω

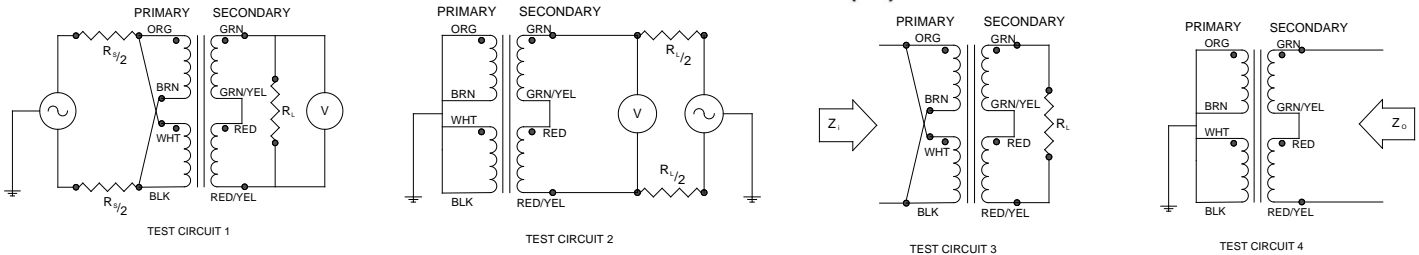
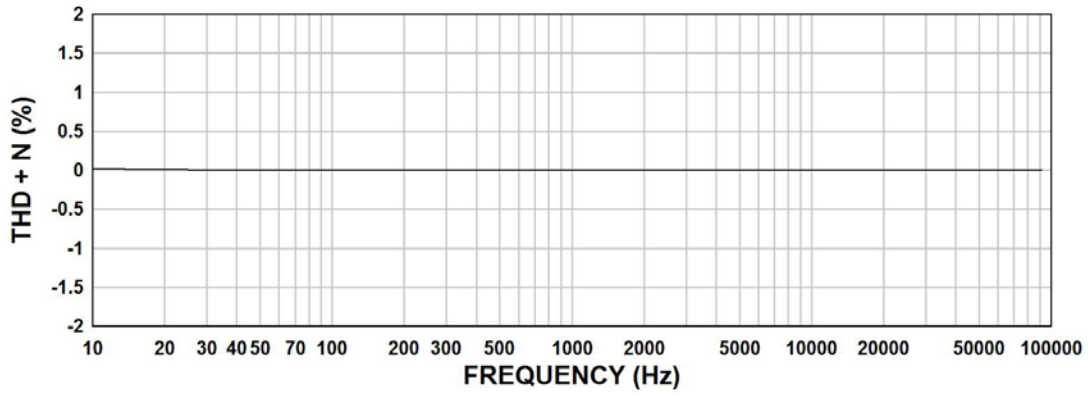

Measurement instruments  
Hp4192a impedance analyzer  
Hp3456a DVM  
Keithley 2002 DVM  
D scope series iii audio analyzer

This drawing and the information in it is the property of Hammond Manufacturing. It may not be reproduced, transmitted or used in any manner whatsoever without the written permission of Hammond Manufacturing. Data subject to change without notice.