



**ELECTRONIC
INNOVATIONS**
IN ACTION

— PRODUCT INFORMATION —

6GK6

Beam Pentode

TUBES

FOR AF POWER AMPLIFIER APPLICATIONS

The 6GK6 is a general-purpose power pentode that may be used either in audio output amplifier or video power output amplifier stages of television receivers.

GENERAL

ELECTRICAL

Cathode - Coated Unipotential
 Heater Characteristics and Ratings
 Heater Voltage, AC or DC* 6.3 ± 0.6 Volts
 Heater Current♦ 0.76 Amperes
 Direct Interelectrode Capacitances, approximate●
 Grid Number 1 to Plate: (g1 to p), maximum.. 0.14 pf
 Input: g1 to (h + k + g2 + g3 + i.s.) 10 pf
 Output: p to (h + k + g2 + g3 + i.s.) 7.0 pf

MECHANICAL

Operating Position - Any
 Envelope - T-6½, Glass
 Base - E9-1, Small Button 9-Pin
 Outline Drawing - EIA 6-4
 Maximum Diameter 0.875 Inches
 Minimum Diameter 0.750 Inches
 Maximum Over-all Length 3.062 Inches
 Maximum Seated Height 2.812 Inches

MAXIMUM RATINGS

DESIGN-MAXIMUM VALUES

Plate Voltage 330▲ Volts
 Screen Voltage 330 Volts
 Negative DC Grid-Number 1 Voltage..... 100 Volts
 Plate Dissipation 13.2▲ Watts
 Screen Dissipation, Average 2.0 Watts
 Screen Dissipation, Peak 4.0 Watts
 DC Cathode Current 65 Milliamperes
 Heater-Cathode Voltage
 Heater Positive with respect to Cathode 100 Volts
 Heater Negative with respect to Cathode..... 100 Volts
 Grid-Number 1 Circuit Resistance
 With Fixed Bias 0.3 Megohms
 With Cathode Bias 1.0 Megohms

PHYSICAL DIMENSIONS

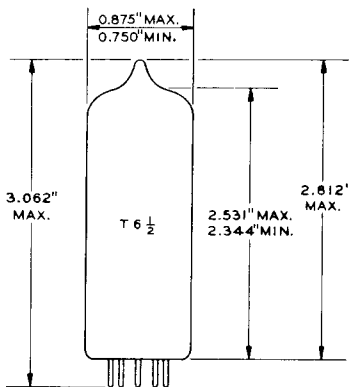

EIA 6-4

TERMINAL CONNECTIONS

- Pin 1 - Cathode
- Pin 2 - Grid Number 1
- Pin 3 - Internal Shield and Grid Number 3 (Suppressor)
- Pin 4 - Heater
- Pin 5 - Heater
- Pin 6 - No Connection
- Pin 7 - Plate
- Pin 8 - Grid Number 2 (Screen)
- Pin 9 - Internal Shield and Grid Number 3 (Suppressor)

BASING DIAGRAM

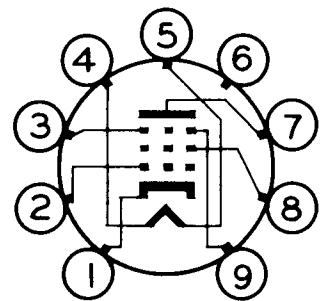

EIA 9GK

The tubes and arrangements disclosed herein may be covered by patents of General Electric Company or others. Neither the disclosure of any information herein nor the sale of tubes by General Electric Company conveys any license under patent claims covering combinations of tubes with other devices or elements. In the absence of an

express written agreement to the contrary, General Electric Company assumes no liability for patent infringement arising out of any use of the tubes with other devices or elements by any purchaser of tubes or others.

MAXIMUM RATINGS (Cont'd)

Design-Maximum ratings are limiting values of operating and environmental conditions applicable to a bogey electron tube of a specified type as defined by its published data and should not be exceeded under the worst probable conditions.

The tube manufacturer chooses these values to provide acceptable serviceability of the tube, making allowance for the effects of changes in operating conditions due to variations in the characteristics of the tube under consideration.

The equipment manufacturer should design so that initially and throughout life no design-maximum value for the intended service is exceeded with a bogey tube under the worst probable operating conditions with respect to supply-voltage variation, equipment component variation, equipment control adjustment, load variation, signal variation, environmental conditions, and variations in the characteristics of all other electron devices in the equipment.

CHARACTERISTICS AND TYPICAL OPERATION

CLASS A₁ AMPLIFIER

Plate Voltage	250	Volts
Screen Voltage	250	Volts
Grid-Number 1 Voltage	-7.3	Volts
Plate Resistance, approximate	38000	Ohms
Transconductance	11300	Micromhos
Zero-Signal Plate Current48	Milliamperes
Zero-Signal Screen Current	5.5	Milliamperes
Load Resistance	5200	Ohms
Total Harmonic Distortion, approximate10	Percent
Maximum-Signal Power Output	5.7	Watts
Amplification Factor of Grid Number 2 with respect to Grid Number 1, zero signal	19	

PUSH-PULL AMPLIFIER, VALUES FOR TWO TUBES

	Class AB		Class B		
Plate Voltage	250	300	250	300	Volts
Screen Voltage	250	300	250	300	Volts
Cathode-Bias Resistor	130	130	---	---	Ohms
Grid-Number 1 Voltage	---	---	-11.6	-14.7	Volts
Peak AF Grid-to-Grid Voltage	22.4	28	22.4	28	Volts
Zero-Signal Plate Current62	.72	.20	.15	Milliamperes
Maximum-Signal Plate Current75	.92	.75	.92	Milliamperes
Zero-Signal Screen Current	7.0	8.0	2.2	1.6	Milliamperes
Maximum-Signal Screen Current	15	22	15	22	Milliamperes
Effective Load Resistance, Plate-to-Plate	8000	8000	8000	8000	Ohms
Total Harmonic Distortion	3.0	4.0	3.0	4.0	Percent
Maximum-Signal Power Output	11	17	11	17	Watts

NOTES

- * The equipment designer should design the equipment so that heater voltage is centered at the specified bogey value, with heater supply variations restricted to maintain heater voltage within the specified tolerance.
- ◆ Heater current of a bogey tube at $E_f = 6.3$ volts.
- Without external shield.
- ▲ When the heater and positive voltage are obtained from a storage battery by means of a vibrator, the maximum values of plate and screen voltages are 275 volts and the plate dissipation is 9.9 watts.

AVERAGE PLATE CHARACTERISTICS

TRIODE CONNECTION

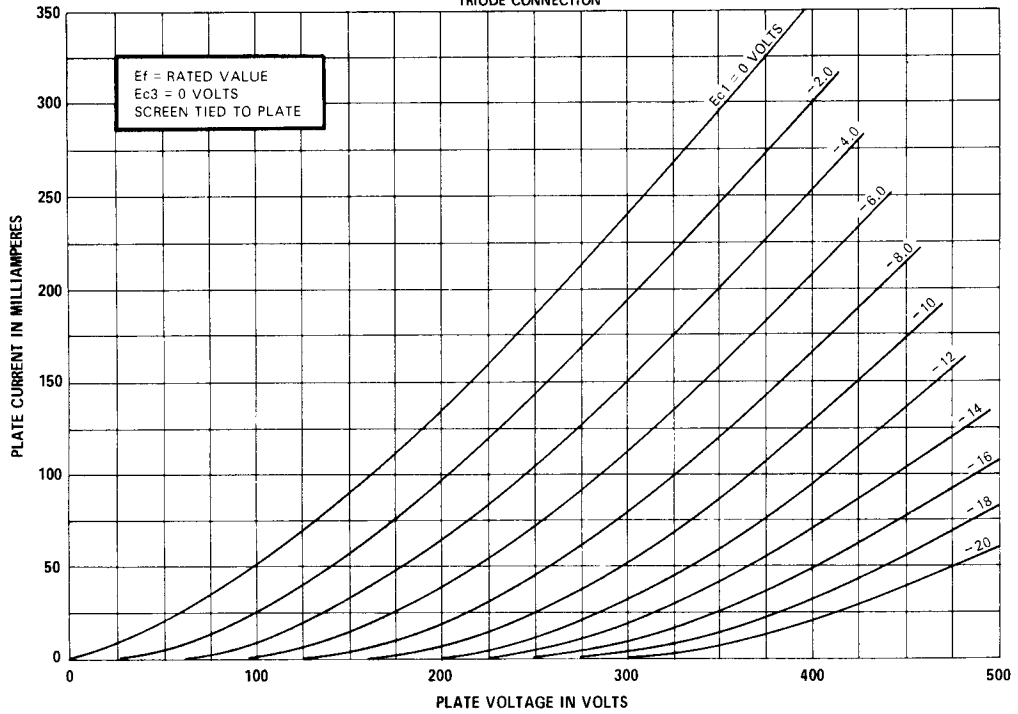

K-55611-TD354-1

MARCH 7, 1968

AVERAGE PLATE CHARACTERISTICS

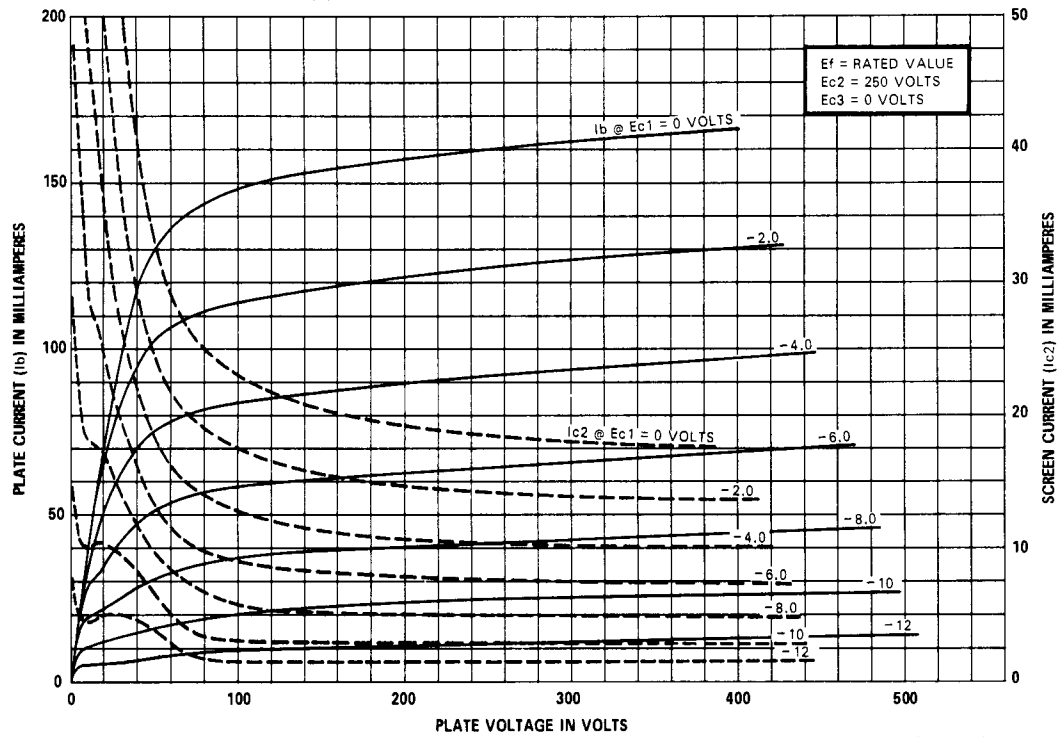

K-55611-TD354-2

MARCH 7, 1968

AVERAGE TRANSFER CHARACTERISTICS

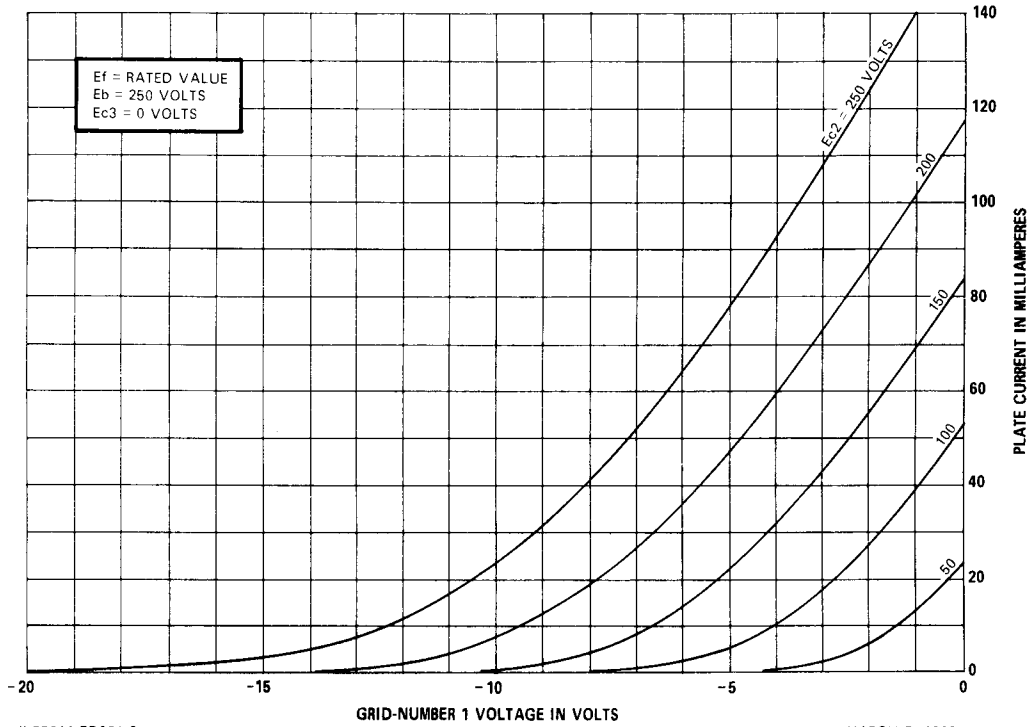

K-55611-TD354-3

MARCH 7, 1968

AVERAGE TRANSFER CHARACTERISTICS

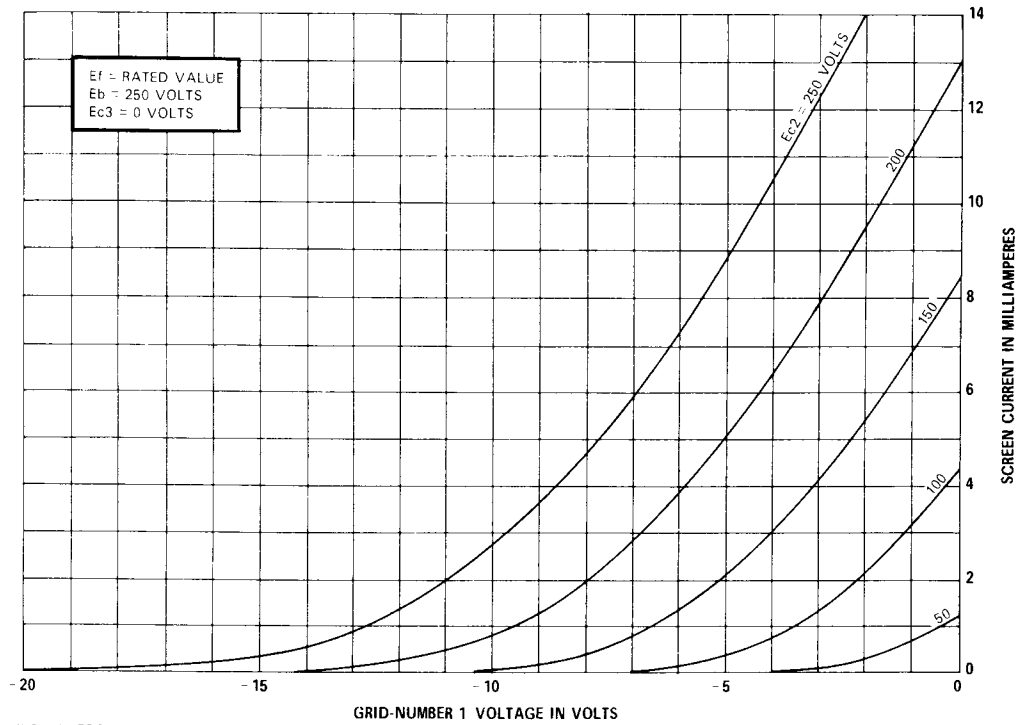

K-55611-TD354-4

MARCH 7, 1968

OPERATION CHARACTERISTICS

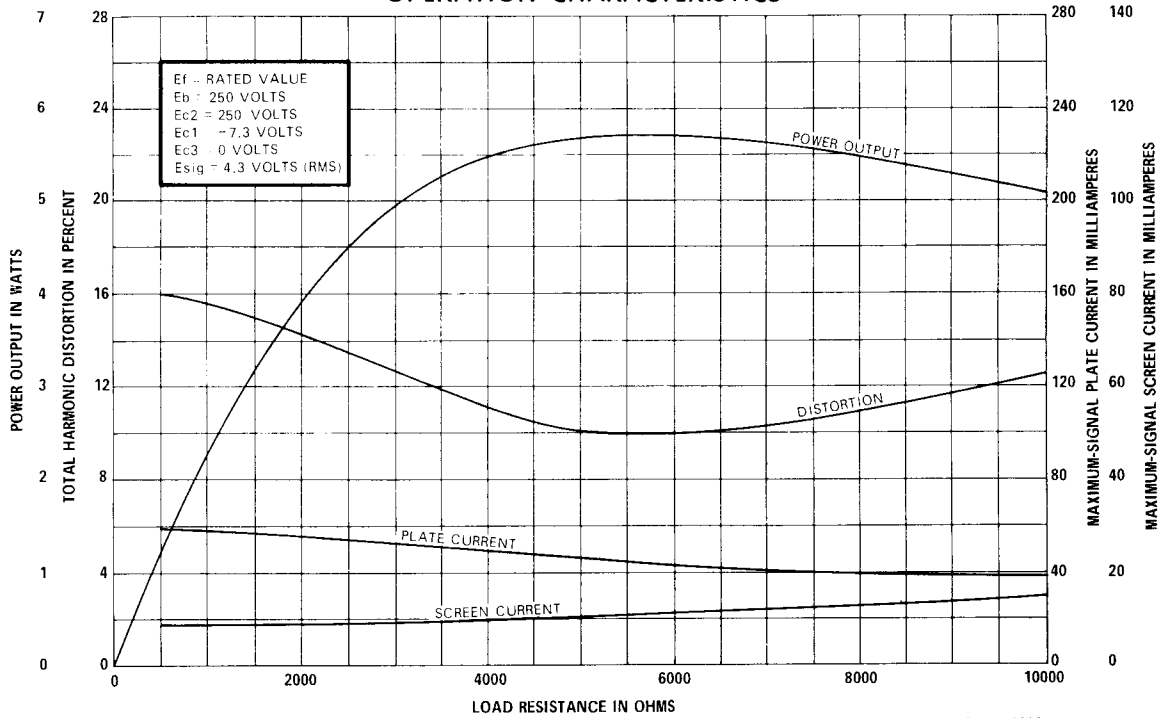

K-55611-TD354-5

MARCH 7, 1968

OPERATION CHARACTERISTICS

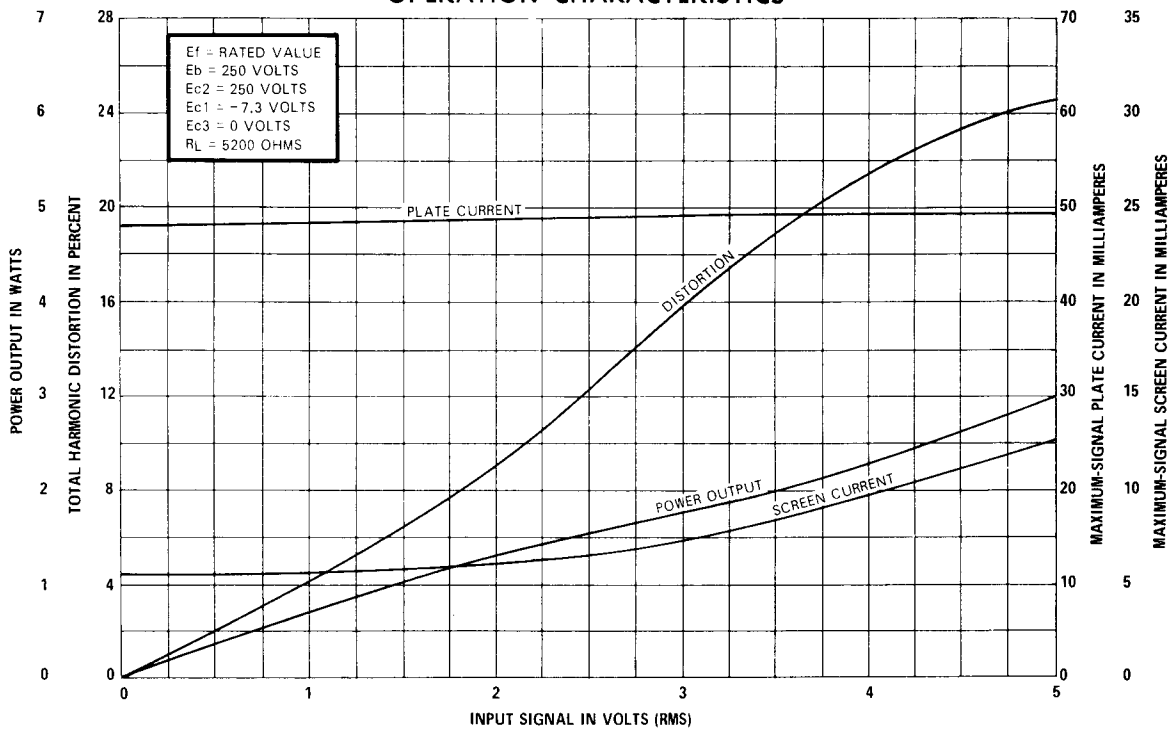

K-55611-TD354-6

MARCH 7, 1968

OPERATION CHARACTERISTICS

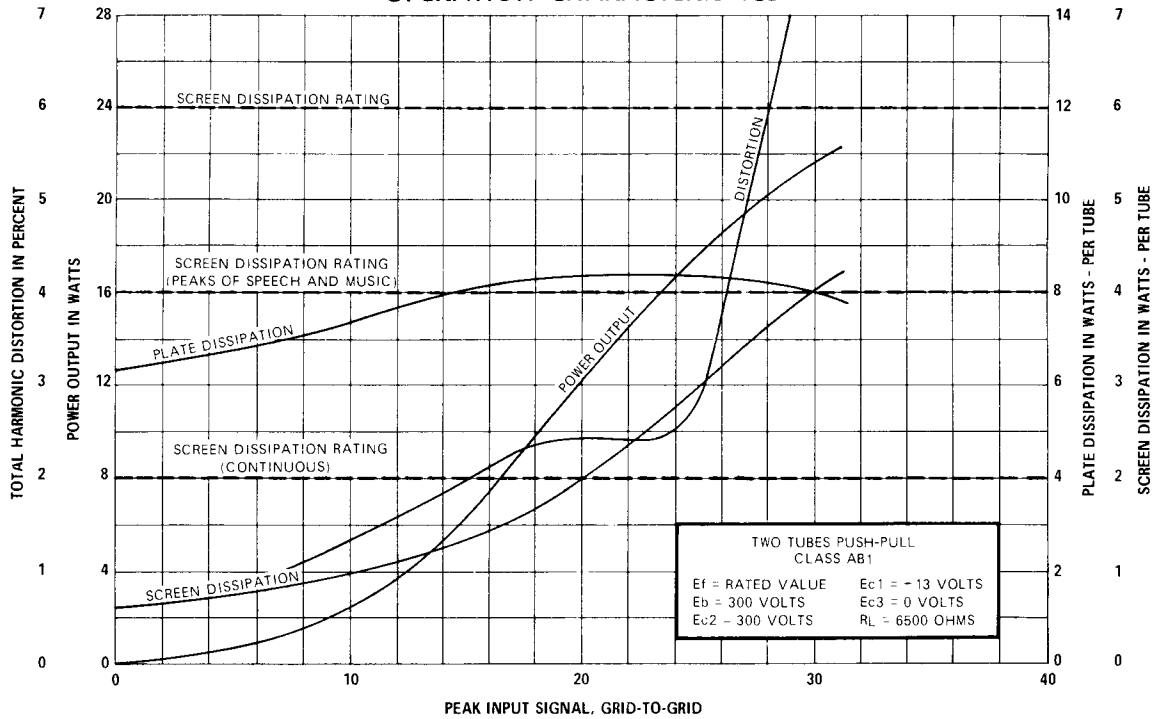

K-55611-TD354-7

MARCH 7, 1968

TUBE DEPARTMENT



Owensboro, Kentucky 42301