

DESCRIPTION AND RATING

The 6AG7 is a metal, power-amplifier pentode primarily designed for use in the output stage of video amplifiers. The tube is capable of operating at high plate current levels and exhibits high transconductance and high power sensitivity.

GENERAL

ELECTRICAL

Cathode—Coated Unipotential		
Heater Voltage, AC or DC	6.3	Volts
Heater Current	0.65	Ampere
Direct Interelectrode Capacitances		
Grid to Plate: (g1 to p), maximum	0.06	μmf
Input: g1 to (h+k+g2+g3+s)	13	μmf
Output: p to (h+k+g2+g3+s)	7.5	μmf
Grid-Number 1 to Grid-Number 2: (g1 to g2), approximate	5.8	μmf
Grid-Number 1 to Cathode: (g1 to k), approximate	5.2	μmf
Heater to Cathode: (h to k), approximate	10.7	μmf

MECHANICAL

- Mounting Position—Any
- Envelope—MT-8, Metal Shell
- Base—B8-21, Small Wafer Octal 8-Pin

MAXIMUM RATINGS

DESIGN-CENTER VALUES

Plate Voltage	300	Volts
Screen Voltage	300	Volts
Positive DC Grid-Number 1 Voltage	0	Volts
Plate Dissipation	9.0	Watts
Screen Dissipation	1.5	Watts
Heater-Cathode Voltage		
Heater Positive with Respect to Cathode	90	Volts
Heater Negative with Respect to Cathode	90	Volts
Grid-Number 1 Circuit Resistance		
With Fixed Bias	0.25	Megohms
With Cathode Bias	1.0	Megohms

Design-center ratings are limiting values of operating and environmental conditions applicable to a bogey tube of a specified type as defined by its published data, and should not be exceeded under normal conditions.

These values are chosen by the tube manufacturer to provide acceptable serviceability of the tube in average applications, taking responsibility for normal changes in operating conditions due to rated supply-voltage variation, equipment component variation, equipment control adjustment, load variation, signal variation, environmental conditions, and variations in the characteristics of all tubes.

The equipment manufacturer should design so that initially no design-center value for the intended service is exceeded with a bogey tube in equipment operating at the stated normal supply-voltage.

The tubes and arrangements disclosed herein may be covered by patents of General Electric Company or others. Neither the disclosure of any information herein nor the sale of tubes by General Electric Company conveys any license under patent claims covering combinations of tubes with other devices or elements. In the absence of an express written agreement to the contrary, General Electric Company assumes no liability for patent infringement arising out of any use of the tubes with other devices or elements by any purchaser of tubes or others.

BASING DIAGRAM

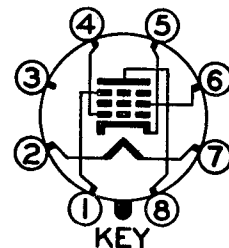

EIA 8Y

TERMINAL CONNECTIONS

- Pin 1—Shell and Grid Number 3 (Suppressor)
- Pin 2—Heater
- Pin 3—No Connection
- Pin 4—Grid Number 1
- Pin 5—Cathode
- Pin 6—Grid Number 2 (Screen)
- Pin 7—Heater
- Pin 8—Plate

PHYSICAL DIMENSIONS

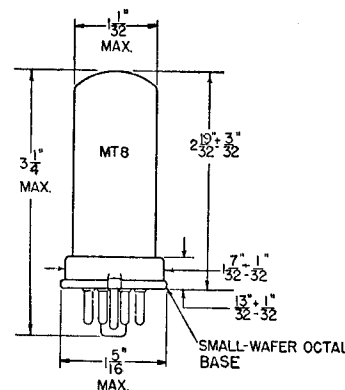

EIA 8-6

CHARACTERISTICS AND TYPICAL OPERATION

CLASS A₁ AMPLIFIER

Plate Voltage.....	300	Volts
Screen Voltage.....	150	Volts
Grid-Number 1 Voltage.....	-3.0	Volts
Peak AF Grid-Number 1 Voltage.....	3.0	Volts
Plate Resistance, approximate.....	130,000	Ohms
Transconductance.....	11,000	Micromhos
Zero-Signal Plate Current.....	30	Milliamperes
Maximum-Signal Plate Current.....	30.5	Milliamperes
Zero-Signal Screen Current.....	7.0	Milliamperes
Maximum-Signal Screen Current.....	9.0	Milliamperes
Load Resistance.....	10,000	Ohms
Total Harmonic Distortion, approximate.....	7	Percent
Maximum-Signal Power Output.....	3	Watts

CLASS A₁ VIDEO VOLTAGE AMPLIFIER

4—Megacycle Bandwidth.

	Grid-Leak* Bias	Cathode Bias	
Plate Supply Voltage.....	300	300	Volts
Screen Voltage.....	115†	125‡	Volts
Grid-Number 1 Voltage.....	0**	-2.0	Volts
Grid-Number 1 Resistor, minimum.....	0.25	—	Megohm
Grid-Number 1 Resistor, maximum.....	0.5	—	Megohm
Cathode-Bias Resistor.....	—	57	Ohms
Cathode Bypass Capacitor, approximate.....	—	250	Microfarads
Grid-Number 1 Signal Voltage, peak to peak.....	4.0	4.0	Volts
Zero-Signal Plate Current.....	45	28	Milliamperes
Zero-Signal Screen Current.....	13	7.0	Milliamperes
Load Resistance.....	3500	3500	Ohms
Output Voltage, peak to peak.....	135	140	Volts

* Intended for use where d-c restoration is accomplished in the grid circuit of the 6AG7.

† Obtained from a regulated power supply.

‡ Obtained from the plate supply voltage through a screen-dropping resistor of 25,000 ohms.

**Zero-signal value.

AVERAGE PLATE CHARACTERISTICS

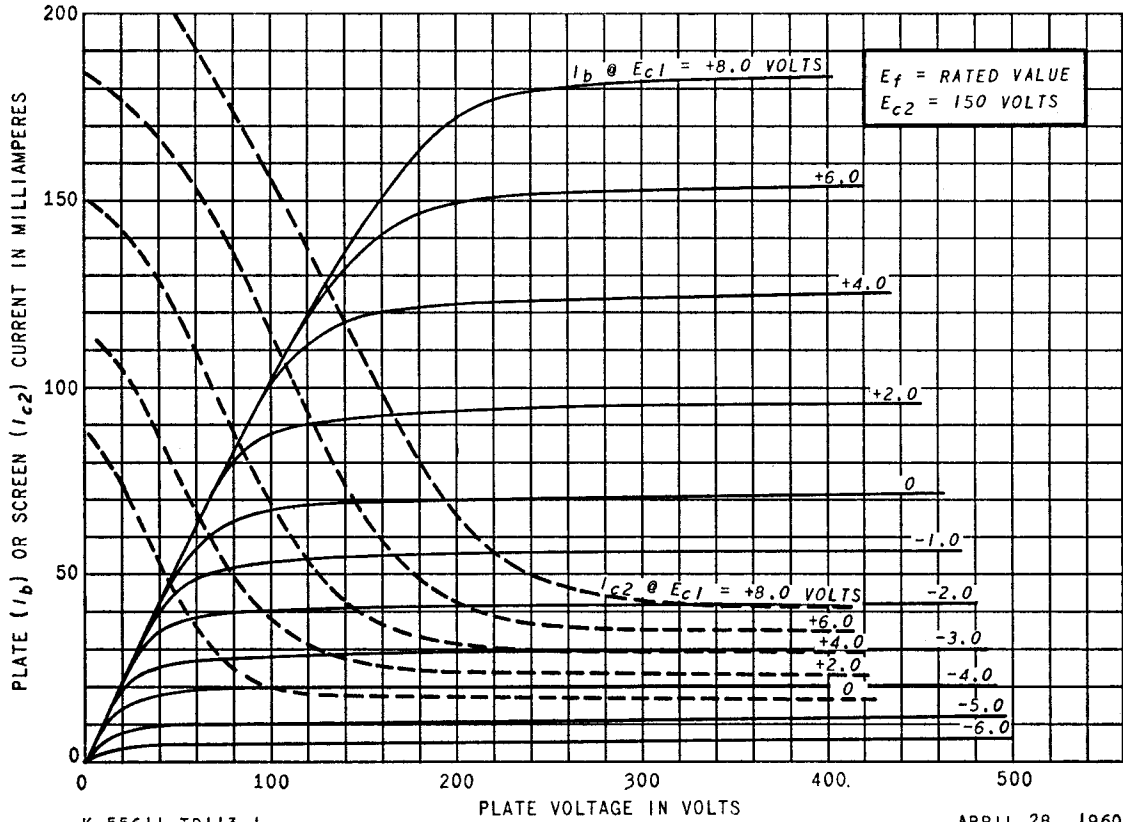

K-55611-TD113-1

APRIL 28, 1960

AVERAGE PLATE CHARACTERISTICS

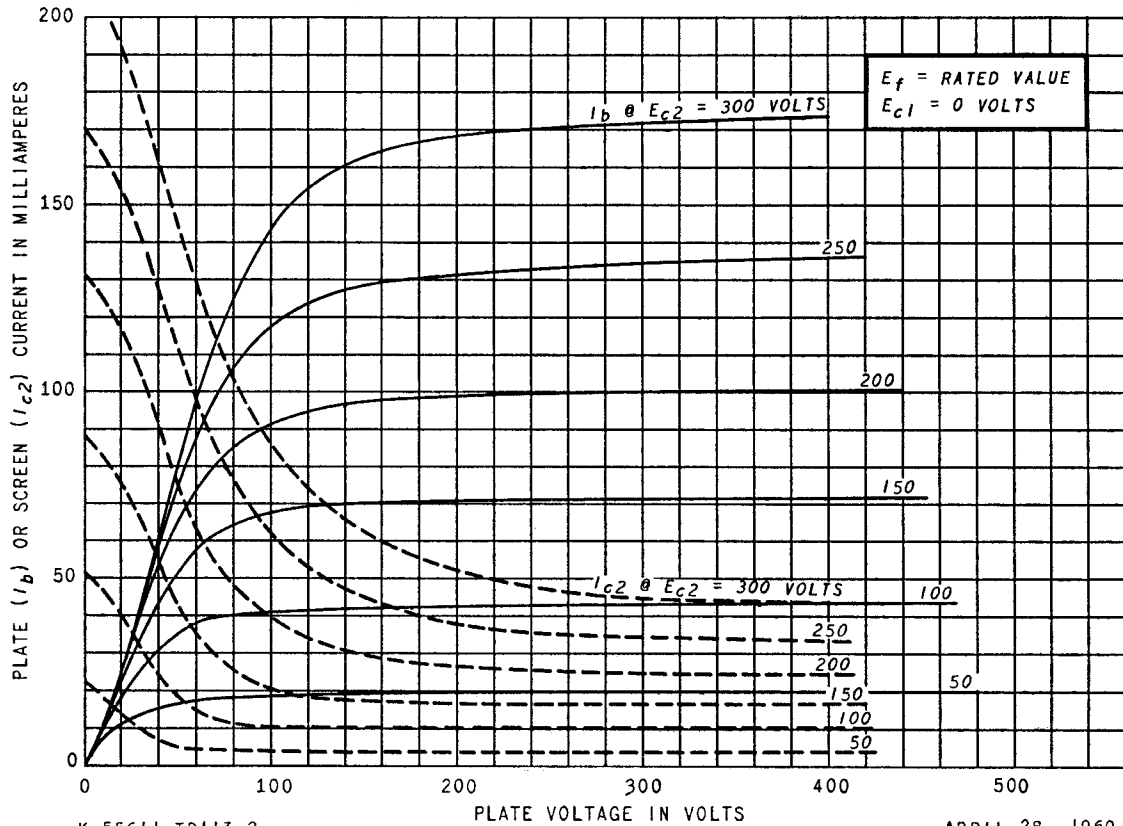

K-55611-TD113-2

APRIL 28, 1960

AVERAGE CHARACTERISTICS

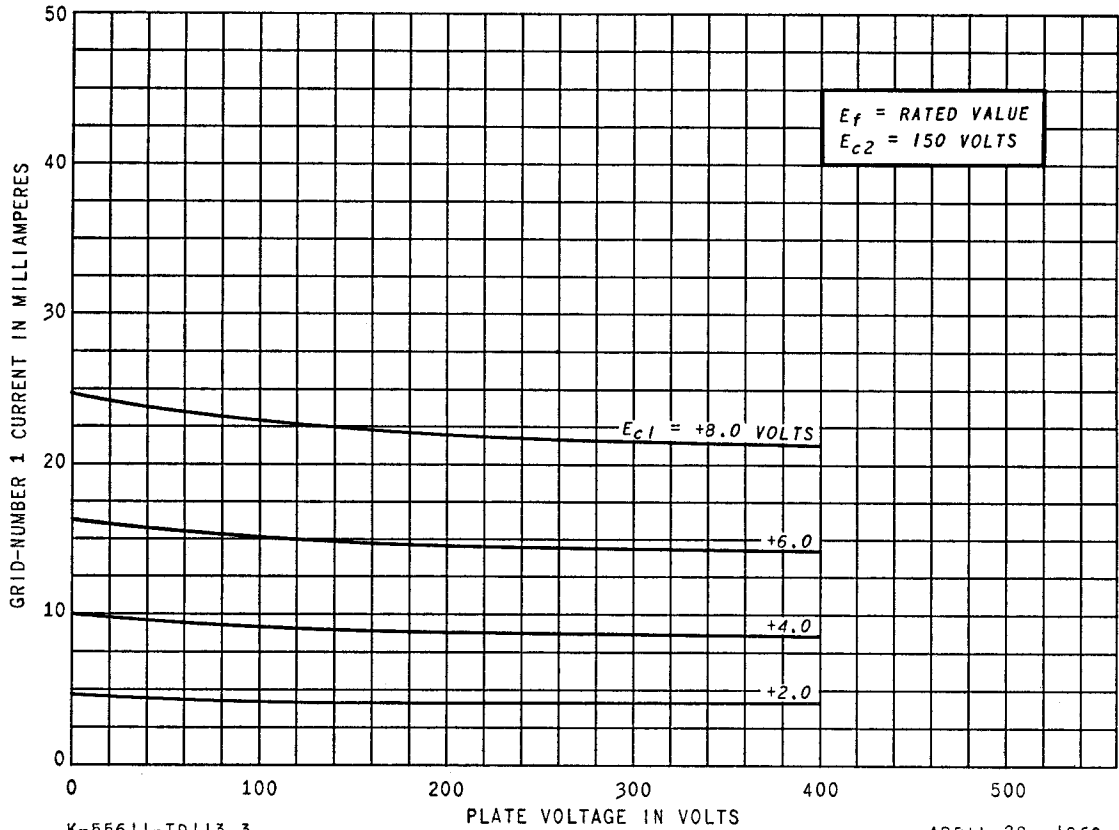

APRIL 28, 1960

AVERAGE TRANSFER CHARACTERISTICS

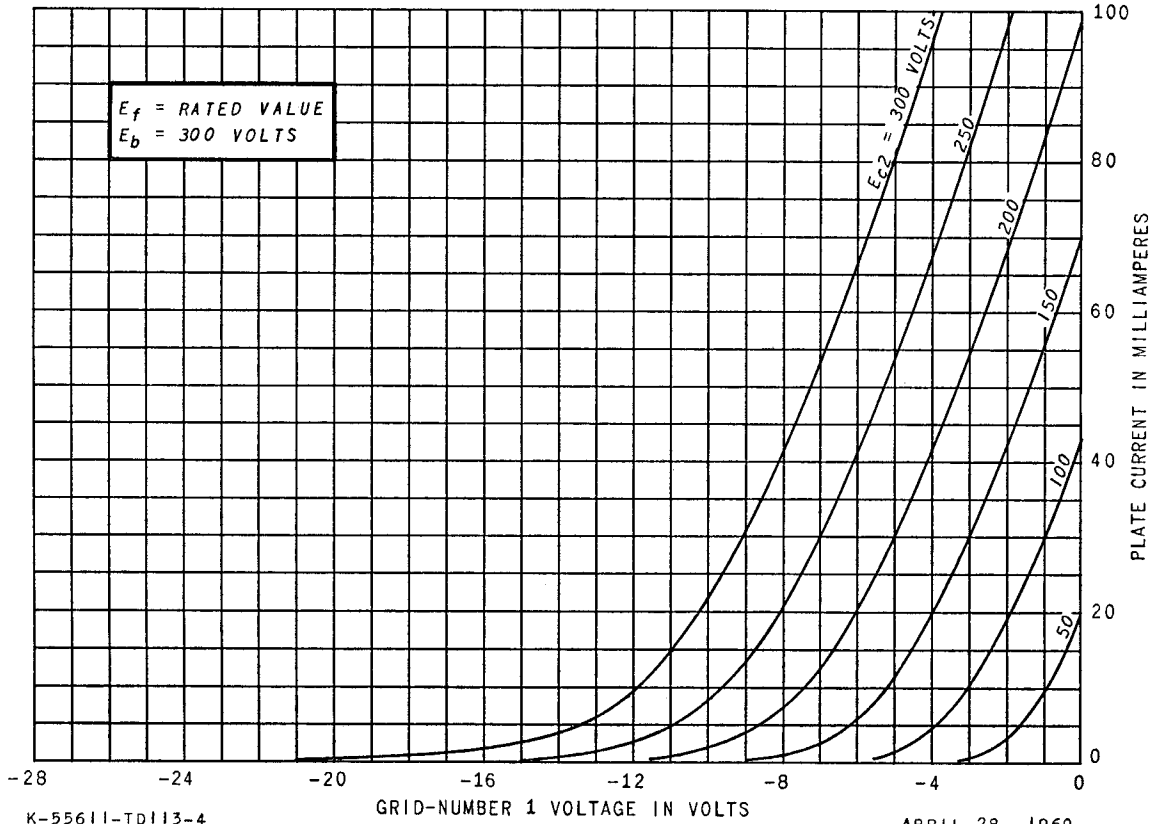

APRIL 28, 1960

AVERAGE TRANSFER CHARACTERISTICS

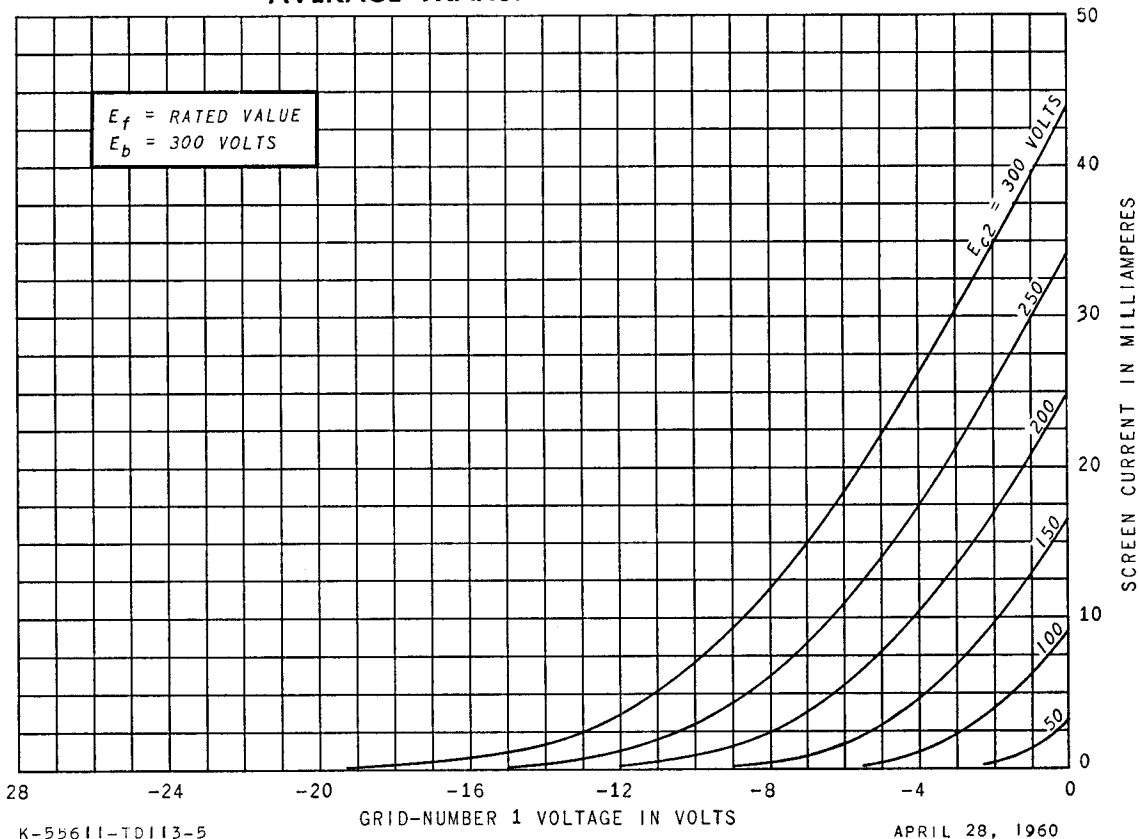

AVERAGE TRANSFER CHARACTERISTICS

